

### 仪器端连接器

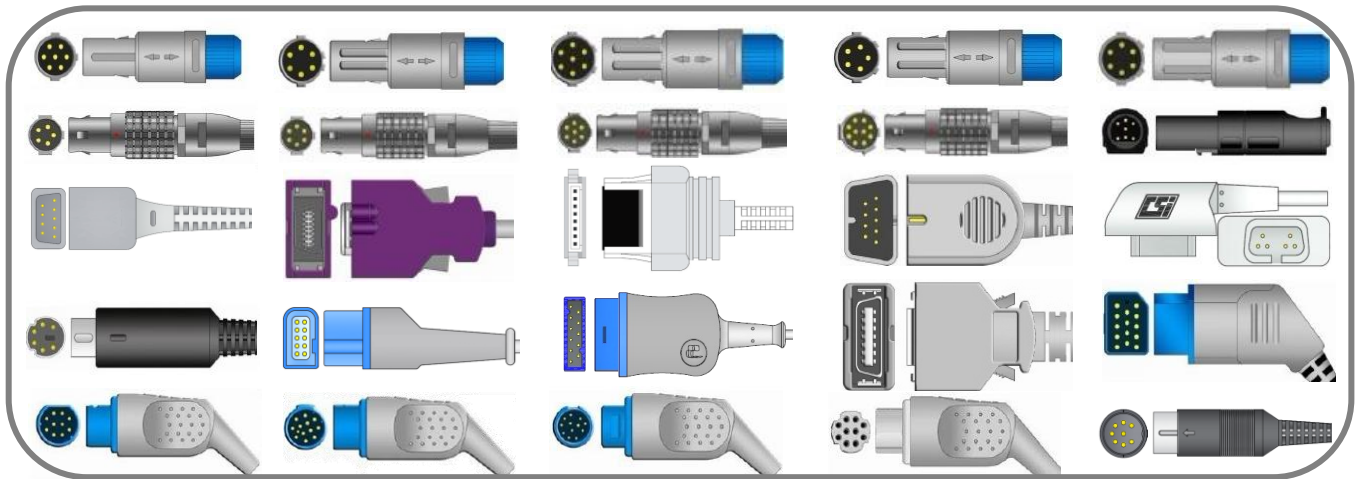

### 探头端连接器

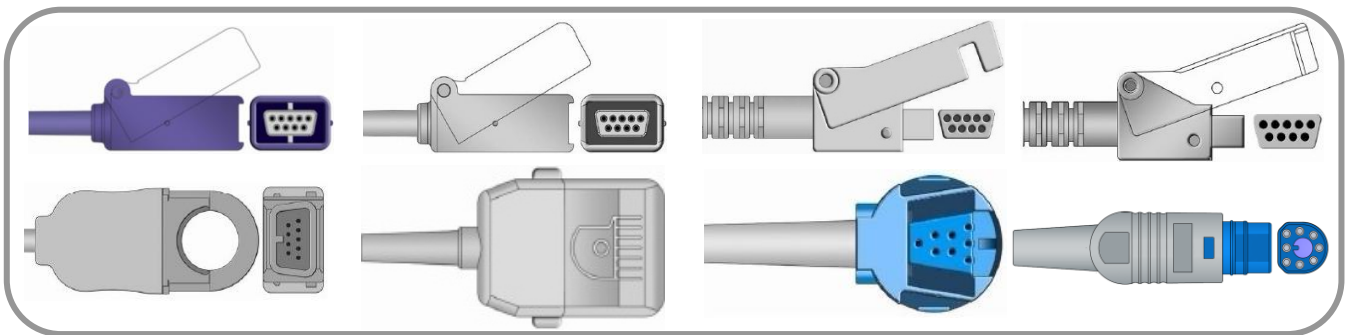



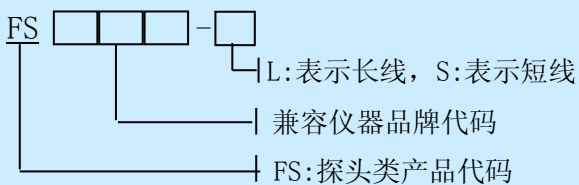







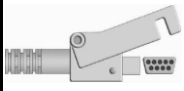

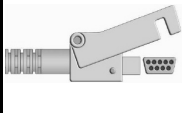

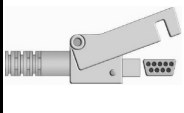

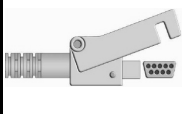

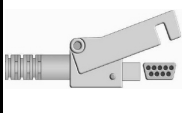
### 产品编码规则

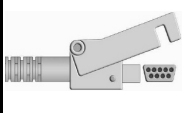

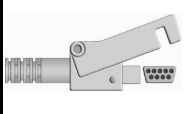

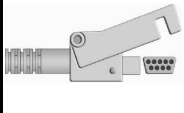

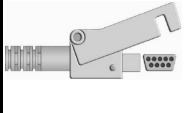

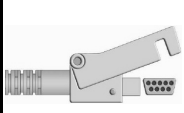





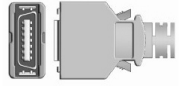
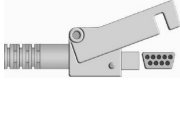
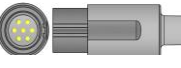
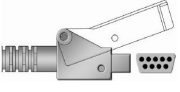

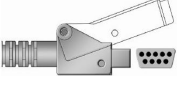

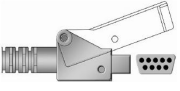
# 血氧转接线

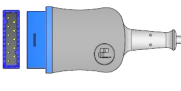
## Spo2 Sensor Extension cable

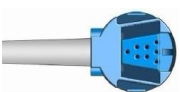
兼容品牌	价格代码	产品编号	原装编号	产品描述	兼容仪器	仪器端	连接器(探头端)
BCI	B4	FS076-L		血氧转接线, L:8ft 插头;DB9M>DB9F, 与BCI短线探头匹配	(Biochem International): 3300,3301,3302,3303,3304,3401		
	B4	FS111-L		血氧转接线, L:8ft 插头;单定位7针雷莫>DB9F, 与BCI短线探头匹配	(Biochem International): 6100,9100, Advisor, Autocorr, Mini Torr BCI (Biochem International), Mini		
韩国品牌 Bionet	C3	FS084-L		血氧转接线, L:8ft 插头;单定位7针雷莫>DB9F, 与Bionet短线探头匹配	Bionet: BM3Vet, BM31		
韩国品牌 Biosys	C0	FS065-L		血氧转接线, L:8ft 插头;MD9M>DB9F, 与Nellcor短线探头匹配	Biosys: BPM300		
布鲁克 Bruker	C5	FS071-L		血氧转接线, L:8ft 插头;圆形12针插头>DB9F, 与BCI短线探头匹配	Bruker: DC-3002,IH,M3		
科瑞康 Creative (China)	D2	FS063-L		血氧转接线, L:8ft 插头;单定位7针雷莫>DB9F, 与BCI短线探头匹配	科瑞康: PC9000, UP6000; 同科博越: TOM MS-6-P 德海尔: DH930; 理邦: M9; 邦健: BM9000; 金科威, 康泰		
CSI	B3	FS044-L		血氧转接线, L:8ft 插头;MD9M>DB9F, 与CSI短线探头匹配	CSI: 503 Spot, 506 Spot, 507SD		
CSI	D3	FS100-L		血氧转接线, L:8ft 插头;金属7针雷莫>DB9F, 与CSI短线探头匹配	CSI: Scholar, Poet (602-3A) , 1100, 501, 503、504, 507, 507SD, 508, 581 Mindray:500A		
Datascope	C5	FS052-L	00 12000 51602	血氧转接线, L:8ft 插头;DIN8P>DB9F, 与Datascope短线探头匹配	Datascope:Accusat Datascope:Accutorr 3/4 SAT Datascope:Accutorr Plus (Datascope Sp02) Datascope: Passport (Database spo2)		
德恩 Datex	C4	FS036-L	Oxy-C3	血氧转接线, L:2.4m, 插头;圆形10孔插头>DB9F, 与德恩短线血氧探头匹配	Datex-Ohmeda:AS/3, CS/3,CH/S, CH/2S, CH-RS, CG/2S,Cardiicap I, Cardiicap II, Cardiicap 5, Capnomac Ultima, Light Monitor, M-Estpr, Oscar II, OSP-200,Satlite Trans, Satlite Trans Plus ,ULTSV1 . ULTSVO, ULTSIO,ULTS00		

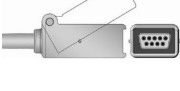
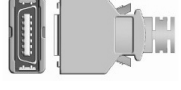

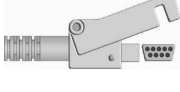

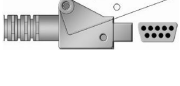





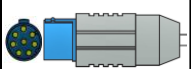
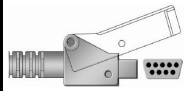

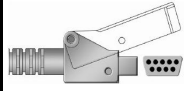

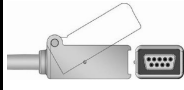



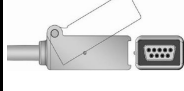

# 血氧转接线

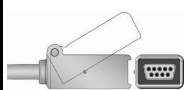
## Spo2 Sensor Extension cable

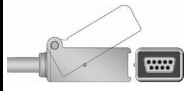
兼容品牌	价格代码	产品编号	原装编号	产品描述	兼容仪器	仪器端	连接器(探头端)
海豚 Dolphin Medical (OSI)	C0	FS099-L	110	血氧转接线, L: 8ft 插头: AMP14P>DB9F 与海豚短线探头匹配	Dolphin ONE Oximeters		
西门子 德尔格 Siemens Drager	C2	FS072-S		血氧转接线, L: 8ft 插头: 圆形7P>DB9F 与奈普特NELLCOR短 线探头匹配	Siemens medical SC 6002XL, SC7000, SC8000, SC9000XL		
海力格 GE- Hellige	C5	FS006-L		海力格血氧转接 线, L: 2. 4m 插头: 圆 形10针>DB9F, 与奈 普特血氧探头匹配	Servomed 4, Generation SCP 844, 851, 852, SCS 804, SMK151, 153, 154, 155-1, 156, 157, SKM181, 182, SMV104T, 107, 111, 168, SMS316, SMC108, SMV104, Servomed N4, Servocard, Serie Cardioserv, Vicom SM, SMU511, 611, 612, 630, Serie SMK-200, SMK210, 211, 230,		
通用-马葵 GE-Medical (NELLCOR模块)	B5	FS002-L	E9004 GE	马葵血氧转接 线, L: 2. 4m 插头: 方 形11针>DB9F, 与奈 普特血氧探头匹配	Medical System: Eagle GE, Dash GE, Solar GE, TRAM Modularx50SL Series ( <i>nellcor mould</i> )		
通用-马葵 GE-Medical (MASIMO模块)	D5	FS025-L		马葵血氧转接 线, L: 2. 4m 插头: 方 形11针>马斯默6pin 母插, 适宜连接马斯 默LNOP血氧探头	Medical System: Eagle GE, Dash GE, Solar GE, TRAM ( <i>masimo mould</i> )		
通用-马葵 GE-Medical (oxi-tech)	F0	FS122-L		DASH2500血氧转接 线, L: 2. 4m 插头: 方 形11针>DB9F, 可兼 容原装DS-100A血氧 探头	GE Medical information technology: dash 2500 <i>Oximax mould</i>		
通用-马葵 GE-Medical ohmeda	D0	FS128-L	OXY- ES3	S/5血氧转接 线, L: 2. 4m 插头: 方 形11针>抓形8孔母 插, 适宜连接欧美达 血氧探头	Sensor solutions for Datex- ohmeda S/5 FM Ports		
INVIVO	D0	FS083-L		血氧转接线, L: 8ft 插头: 7针雷莫 >DB9F, 适宜连接奈 普特血氧探头	4500、4500Plus, Millenia, Omega1445, Omni-TrakTVS Sat Scout, original cable number 9383		
马斯默 Masimo	C5	FS020-L		血氧转接线, L: 8ft 插头: AMP14P>马斯 默6pin母插, 适宜连 接马斯默LNOP血氧 探头	GE: PRO1000, V300 INVIVO:T8 , Schiller, ZOLL, Masimo Datascope: Trio, Passport 2, Spectrum		
美克 MEK	B5	FS018-L		美克血氧转接线, L: 2. 4m, 插头: DB9M>DB9F, 适宜美 克血氧探头	New Modle Mahine of MEK 8PIN Jack		
美能 Mennen	F0	FS009-L	261 87801 0	血氧转接线, L: 8ft 插头: FGG. 2b. 10针 雷莫>DB9F, 适宜连 接奈普特血氧探头	Horizon2000		

# 血氧转接线

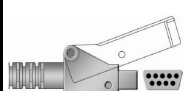
## Spo2 Sensor Extension cable

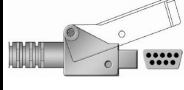
兼容品牌	价格代码	产品编号	原装编号	产品描述	兼容仪器	仪器端	连接器(探头端)
美能 Mennen	D0	FS103-L		美能血氧转接线, L:8ft 插头: 圆形8p>DB9F, 适宜连接奈普特血氧探头			
康强 Kontron	C2	FS019-L		康强血氧转接线, L:8ft 插头: 圆形12p>DB9F, 适宜连接奈普特血氧探头	Kontron 7840, 7845, Minimon7137, Kolormon, Micromon, Supermon, Trakmon		
迈瑞 MINDRAY (China)	C7	FS000-L		血氧转接线L:2.4m 插头: 单定位5针雷莫>DB9F, 适宜连接马斯默血氧探头	Mindray PM9000; Goldway: UT4000A; Jerry: PM2000; Hongrunda: EM-6.		
迈瑞 MINDRAY (China)	C7	FS040-L	0010-20-42594	血氧转接线L:2.4m 插头: 40度双定位6针雷莫>DB9F, 适宜连接奈普特血氧探头	PM7000,8000,9000,1000 <i>(Nellcor &amp; mindray 模块)</i>		
迈瑞 MINDRAY (China)	C7	FS116-L	0010-30-42602	血氧转接线L:2.4m 插头: 40度双定位6针雷莫>DB9F, 适宜连接马斯默血氧探头	PM7000,8000,9000,1000 <i>(masimo 模块)</i>		
迈瑞 MINDRAY (China)	B0	FS045-L	0010-21-11957	血氧转接线L:2.4m 插头: 圆形12针插头>DB9F, 适宜连接奈普特血氧探头	PM5000, PM6000, PM8100 <i>(Nellcor &amp; mindray 模块)</i>		
迈瑞 MINDRAY (China)	C8	FS012-L	0010-30-12452	血氧转接线L:2.4m 插头: 圆形12针插头>DB9F, 适宜连接马斯默血氧探头	PM5000, PM6000, PM8100 <i>(masimo 模块)</i>		
迈瑞 MINDRAY (China)	C5	FS011-L	512A-30-06074	血氧转接线L:2.4m 插头: 兼容雷莫1B金属5针雷莫>DB9F, 适宜连接CSI血氧探头	MEC509, MEC509+, MEC503, MEC507		
迈瑞 MINDRAY (China)	C5	FS129-L	512A-30-06074	血氧转接线L:2.4m 插头: 80度双定位6针雷莫>DB9F, 适宜连接CSI血氧探头	MEC509, MEC509+, MEC503, MEC507		
奈普特 NELLCOR	B0	FS001-L	SCP-10	血氧转接线, L:2.4m 插头: AMP14P>DB9F 适宜连接奈普特血氧探头	Nellcor , without oximax		
奈普特 NELLCOR	A8	FS010-L	EC-8	血氧转接线, L:2.4m 插头: DB9M>DB9F 适宜连接奈普特血氧探头	Datascope:Expert,Passport GE :Corometrics 188 Corometrics 129 Critikon Dinamap 9700 Critikon Dinamap 9710 Critikon Dinamap 9720 Plus Critikon Dinamap Compact Critikon Dinamap		















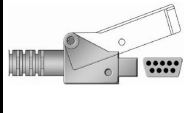

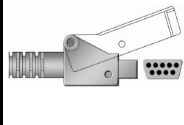

# 血氧转接线 Spo2 Sensor Extension cable

兼容品牌	价格代码	产品编号	原装编号	产品描述	兼容仪器	仪器端	连接器(探头端)
奈普特 NELLCOR	C5	FS117-L	DOC-10	血氧转接线, L: 2.4m 插头: AMP14P>DB9F 适宜连接奈普特OXI技术的血氧探头	GE Dinamap PRO (w/Oxi)、 Datascope: Accutorr Plus (Nellcor® SpO2) Nellcor: NPB-290/5 (w / Oxi)、 Nellcor: N-390 (w / Oxi)、 Nellcor: N-395 (w / Oxi)、 Nellcor: N-3000 (w / Oxi)、 Nellcor: N-6000 (w / Oxi)、 Nellcor: NPB-290/5 (w / Oxi)、 Nellcor: N-390 (w / Oxi)、 Nellcor:		
奈普特 NELLCOR	C8	FS026-L	DEC-8	血氧转接线, L: 2.4m 插头: DB9M>DB9F 适宜连接奈普特OXI技术的血氧探头	Nellcor: N-390 (w / Oxi)、 Nellcor:		
日本光电 Nihon Konden	E8	FS005-L	TL-201T	日本光电血氧转接线, L: 2.4m, 方形14针 插头>DB9F, 适宜连接日本光电血氧探头	BSM-4101, 4103, 4111, 4113, 5105, 5135, 2351, 2353, 2301, 2303		
	C0	FS069-L		日本光电血氧转接线, L: 2.4m, 圆形10针 插头>DB9F, 适宜连接日本光电血氧探头	AL-800PA, BSM-1101, 2101, 2102, 3101, 7100, 7200, 8200, 8201, 8301, 8302, SM-8800, OLV-1100A		
燕牌 Nonin	C5	FS080-L		血氧转接线, L: 8ft 插头: FGG. 1b. 6针雷莫>DB9F, 适宜连接Nonin短线探头	8604、8604D		
燕牌 Nonin	D0	FS109-L		血氧转接线, L: 2.4m, 插头: 杜邦8孔插头>DB9F, 适宜连接燕牌血氧探头	8600 series, 8500, 8700, 8800, 9600, 9700		
诺医 Novamatrix	C2	FS062-L	8776-00	血氧转接线, L: 8ft, 插头: 塑Hys-7p>DB9F, 适宜连接Novamatrix短线探头	Nuoyi: 505, 510, 511, 515B/C, 520, 7000, 7100, Oxypleth Spacelabs: 90351-D/G, 90465, 90466, 90467, 90489, 90651-07/08, 90419-01, 90651A-07		
欧美达 Ohmeda	C2	FS014-L		血氧转接线, L: 8ft, 插头: 塑Hys-7p>DB9F, 适宜连接欧美达短线探头	Ohmeda: 3700, 3710, 3770, 3775, Biox3740, 3760, 3800 OxiCap, 4700 OxiCap, 5250RGM		
欧美达 Ohmeda	D0	FS0140-L		血氧转接线, L: 8ft, 插头: 塑Hys-7p>8J, 适宜连接欧美达短线探头	Ohmeda: 3700, 3710, 3770, 3775, Biox3740, 3760, 3800 OxiCap, 4700 OxiCap, 5250RGM		
伯斯特 Pace Tech 将军 General	C5	FS082-L	4510	血氧转接线, L: 8ft, 插头: 迷你卡龙5J>DB9F, 适宜连接BCI短线探头	Pace Tech: All w/black face (except Vitalmax 800 w/Nellcor SPO2) Generra: 200, 300, 400, 530, 710, 810		
	B4	FS091-L		血氧转接线, L: 8ft, 插头: 单定位7P雷莫>DB9F, 适宜连接BCI短线探头	Generra		

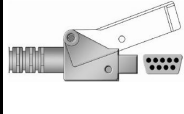

# 血氧转接线

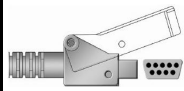
## Spo2 Sensor Extension cable

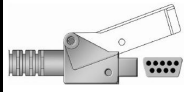
兼容品牌	价格代码	产品编号	原装编号	产品描述	兼容仪器	仪器端	连接器(探头端)
飞利浦 PHILIPS	C4	FS015-L	M194 1A	飞利浦血氧转接线,L:2.4m,半圆形8针插头>半圆形8孔母座,适宜连接飞利浦血氧探头	M2601A, M3000A, M3500B, M4735A		
飞利浦 PHILIPS	B0	FS0150-L	M194 3A	飞利浦血氧转接线,L:2.4m,半圆形8针插头>DB9F,适宜连接奈普特血氧探头	M2601A, M3000A, M3500B, M4735A		
飞利浦 PHILIPS	C2	FS003-L	M194 0A	飞利浦血氧转接线,L:2.4m,半圆形12针插头>半圆形8孔母座,适宜连接飞利浦血氧探头	M2475B, M1732A/B, M1722A/B, M1020A, 78833A, 78833C, 78834A, 78352A, 78352C		
飞利浦 PHILIPS	C3	FS0030-L	M190 0B	飞利浦血氧转接线,L:2.4m,半圆形12针插头>DB9F,适宜连接奈普特血氧探头	M2475B, M1732A/B, M1722A/B, M1020A, 78833A, 78833C, 78834A, 78352A, 78352C		
丹麦阿堤玛 S&W Artema	C2	FS023-L		血氧转接线,L:2.4m,半圆形10孔插头>DB9F,适宜连接NELLCOR短线血氧探头	S&W (Diascope G2) Patient monitor, Diascope 1, 2, 3		
席勒 Schiller	C0	FS028-L		席勒血氧转接线,L:2.4m,DIN式7针插头>DB9F,适宜连接奈普特血氧探头	Schiller Argus TM-7		
席勒 Schiller	D0	FS118-L		席勒血氧转接线,L:2.4m,DIN式7针插头>马斯默6pin,适宜连接马斯默血氧探头	Argus Pro, Argus LCM		
西门子 SIEMENS	C5	FS078-L		血氧转接线,L:8ft,插头:圆形10P插头>DB9F,适宜连接NELLOCOR短线探头	Siemens medical:Sirecust 630, Sirecust 700, Sirem SPO2 Module		
太空 SPACELAB S	C2	FS035-L	700-0020-00	老太空血氧转接线,L:2.4m,插头:伊倍达12针插头>DB9F,适宜连接奈普特血氧探头	Spacelabs: 90351-0/6, 90465, 0466, 90489, 90651A-08, 90651-A, IM77, 90303, PC Scout		
	C5	FS004-L	700-0030-00	老太空血氧转接线,L:2.4m,插头:方形10针插头>DB9F,适宜连接奈普特血氧探头	Spacelabs-1050, 1600, 1700, 90369, 90469, 90496	